



Catalogue

Table of Contents

Surgical Instruments	3
Sterile Surgical Draping Facts	5
Sterile Surgical Draping and PPEs'	6
Disposable Medical Bed Sheet	6
Disposable Medical Bed Sheet	6
Disposable Medical Bed Cover	6
Disposable Medical Bed Sheet	7
Disposable Medical Bed Sheet	7
Disposable Medical Bed Sheet	7
Biodegradable bed sheet	7
Disposable Medical Bed Sheet	8
Disposable Medical Bed Sheet	8
Adhesive Drape	8
Biodegradable surgical drape with adhesive	8
Surgical drape with Hole	8
Surgical Drape	9
Surgical Drape	9
Standard Surgical Gown	9
Reinforced Surgical Gown	9
Patient gown	9
Bouffant cap.....	10
Medical Face Mask Disposable.....	10
Disposable Shoe Covers.....	10
Sterile Disposable Packs	11
Universal Pack	11
Laparoscopy Pack	11
Laparotomy Pack	11
Split Drape Pack	12
Orthopedic Procedure Pack.....	12
Shoulder Beach Chair Drape.....	12
Shoulder Arthroscopy Drape	13
Hand Pack with Gown.....	13
Hand &Foot Pack with Gown	13
Knee Arthroscopy Pack with Gown.....	14
Hip Pack with Gown	14
Orthopedic pack with Gown	14
Disposable Sterile C-Section Surgical Pack.....	15
Disposable Sterile Caesarean Pack	15
Obstetrics Pack.....	16
Lithotomy Pack.....	16
Ophthalmology Surgery Drape Pack	17

Ear, Nose & Throat Pack	17
Neuro Pack	18
Craniotomy Drape	18
Craniotomy T Drape	18
Angiography Drape Pack	19
Angiography Drape	19
Radial Femoral Angiography Drape	19
Femoral Angiography Drape with Pouch	20
Brachial Angiography Drape	20
Cardiovascular Pack	20

Futuremed Supplies (Pty) Ltd

Website: www.futuremed.co.za; Email: sales@futuremed.co.za ; Tel: +27 791 4413

Surgical Instruments

General Surgical Instruments

- Scalpels, knives
- Scissors
- Forceps
- Artery Forceps
- Sponge Forceps
- Probes, Cotton Applicators
- Trocars, Suction Tubes
- Suture Instruments
- Dressing Instruments

Abdomen, Gynecology & Obstetrics

- Gynecology Instruments
- Obstetrical Instruments
- Stomach, Intestine & Rectum Instruments
- Liver, Gallbladder, Kidney & Urology Instruments

ENT, Tonsillectomy & Tracheotomy

- Oral & Maxillofacial Instruments
- Otology Instruments
- Rhinology Instruments
- Tonsillectomy & Laryngo - Bronchoscopy Instruments

Trauma, Dermatology & Podiatry

- Orthopedic Instruments
- Skin Grafting Instruments
- Dermatology Instruments
- Podiatry Instruments

Cardiovascular, Neuro & Ophthalmic Surgery

- Thorax & Cardiovascular Instruments
- Neurosurgery Instruments
- Ophthalmic Instruments

Diagnostic & Anesthesia

- Diagnostic Instruments
- Anesthesia Instruments

Dental Instruments

- Diagnostic Instruments
- Extraction Instruments
- Periodontal Instruments
- Endodontic Instruments
- Restorative Instruments
- Orthodontic Instruments

Holloware & Sterilization

- Holloware
- Sterilization Instruments

LIFETIME WARRANTY

Our instruments are guaranteed for life* against manufacturing defects of material and workmanship. This means will repair or replace free of charge any surgical instrument that does not meet its functional requirements when used for the intended purpose and maintained properly.

* Conditions apply



Futuremed Supplies (Pty) Ltd

Website: www.futuremed.co.za; Email: sales@futuremed.co.za ; Tel: +27 791 4413

Sterile Surgical Draping Facts

QUALITY

Based on the experience and skills established over the years, our partners have developed a range of materials that not only meets but exceeds the regulatory standards of EN13795, EN866-2 and ISO 11607-1, thereby ensuring the highest level of protection to patients and surgical teams. Testing is undertaken for the full range of products. Their market leading performance is confirmed by the testing of absorbency, spread and run off.

MATERIAL TYPES AND FEATURES

Different Procedures require different levels of protection. Therefore, we offer a choice of fabric and reinforcements. All our fabrics are latex free.

COMPLIANCE

Their products are CE marked in accordance with the medical Device Directive 93/42/EEC.

Their Plants are Certified to:ISO9001, ISO13485 and Directive 93/42/EEC

Their products are certified to:ISO9001, ISO 13485 and Directive 93/42/EE

MATERIAL PROPERTIES

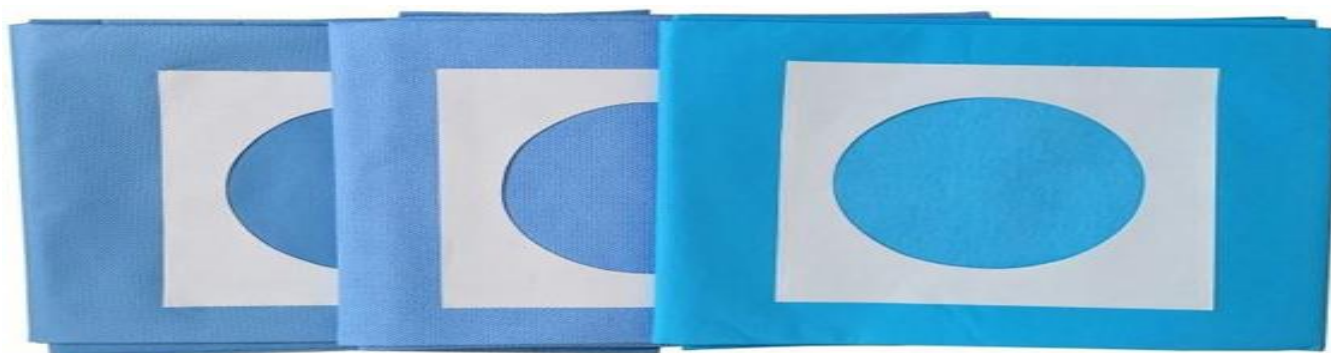

1. Use with steam and EO sterilization. Each packaged product is clearly labeled and identified for its sterilization status.
2. Comply with EN13795/2011 and YY0506:2009 standards.
3. Comply with ANSI/AAMI PN70:2003 standards-Liquid barrier performance and classification of protective apparel and drapes intended for use in healthcare facilities.
4. The fabric has been thoroughly evaluated and test for biocompatibility and the fabric shows no toxicity and no skin irritation and does not cause any allergic reaction.



Futuremed Supplies (Pty) Ltd

Website: www.futuremed.co.za; Email: sales@futuremed.co.za ; Tel: +27 791 4413

Sterile Surgical Draping and PPEs'





Item No	Product Name	Feature	Picture
LTB-001	Disposable Medical Bed Sheet	Material: PP nonwoven Feature: Soft Gram weight:25g size:140*220cm	
LTB-002	Disposable Medical Bed Sheet	Material: SMS Feature: Soft Gram weight:30g size:140*220cm	
LTB-003	Disposable Medical Bed Cover	Material: PP nonwoven or SMS Feature: Soft Gram weight:25g -70g size:140*220cm	

LTB-004	Disposable Medical Bed Sheet	<p>Material: PP+viscose(nonwoven) Feature: Waterproof and Absorbent Gram weight:50g, Size: 60*90cm</p>	
---------	------------------------------	---	---

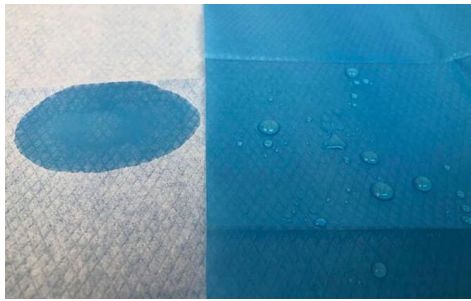

LTB-005	Disposable Medical Bed Sheet	<p>Material: PP+hydrophilic Feature: Waterproof and Absorbent Size: 60*90cm, 80*120cm, 100*200cm</p>	
---------	------------------------------	--	--

LTB-006	Disposable Medical Bed Sheet	<p>Material: PP+SMS Feature: Waterproof Size: 60*90cm, 80*120cm, 100*200cm</p>	
---------	------------------------------	--	--

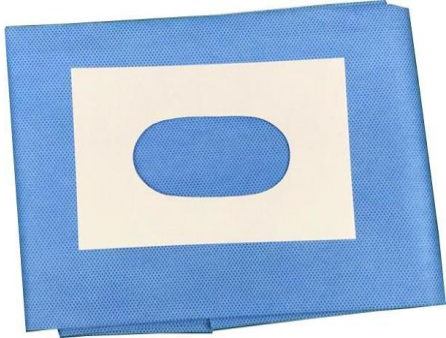
LTB-007	Biodegradable bed sheet	<p>Material: Corn fiber Feature: 100% biodegradable Size: 60*90cm, 80*120cm, 100*200cm</p>	
---------	-------------------------	--	--

LTB-007	Disposable Medical Bed Sheet	Material: PP+Tissue Paper Feature: Waterproof and Absorbent Size: 60*90cm, 80*120cm, 100*200cm	
LTB-008	Disposable Medical Bed Sheet	Material: Microporous PE+Hydrophilic PP Feature: Waterproof, water absorption and breathable Size: 60*90cm, 80*120cm, 100*200cm	
LTD-001	Adhesive Drape	Material: SMS, PP+SMS, PP+hydrophilic, PP+viscose Feature: Waterproof Size: 60*90cm, 80*120cm, 100*200cm	
LTD-002	Biodegradable surgical drape with adhesive	Material: wood pulp+fiber Feature: biodegradable Size: 60*90cm, 80*120cm, 100*200cm	
LTD-003	Surgical drape with Hole	Material: SMS, PP+SMS, PP+hydrophilic, PP+viscose Feature: Waterproof Size: 60*90cm, 80*120cm, 100*200cm	

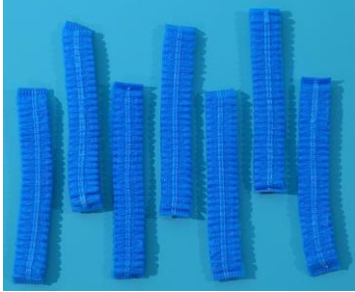
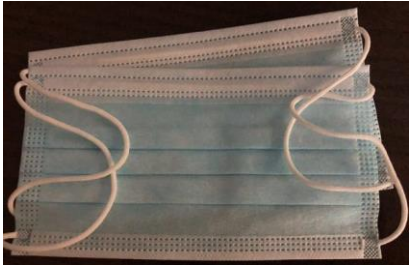
LTD-004	Surgical Drape	Material: SMS , Three-anti SMS Size: 60*90cm, 80*120cm, 100*200cm	
LTD-005	Surgical Drape	Material: PE+Hydrophilic , PE+Viscose, PE+SMS Feature: Waterproof and Absorbent Size: 60*90cm, 80*120cm, 100*200cm	
LTG-002	Standard Surgical Gown	(M)115*150cm	
		(L)125*157cm	
		(XL)140*165cm	
		(XXL)155*170cm	
LTG-002	Reinforced Surgical Gown	(M)115*150cm	
		(L)125*157cm	
		(XL)140*165cm	
		(XXL)155*170cm	
LTG-003	Patient gown	Material: 45gsm SMS, Size: Shirt 75*120cm, Pants 100*125cm elastic waist	

		Material: 45gsm SMS, Size: L, Shirt 80*124cm, Pants 110*130cm elastic waist	
LT/C17	Bouffant cap	PP non-woven fabric ,18", 10gsm	
LT/C18	Medical Face Mask Disposable	PP non-woven, ear loop, 3ply 18+18+18 Hypoallergenic, adjustable nose piece, high filtration capacity	
LT/C22	Disposable Shoe Covers	PP non-woven, 20gsm	

Sterile Disposable Packs

Universal Pack

No	Description	QTY	Picture
1	Back Tale Cover 140*190CM	1	
2	Mayo Stand Cover 78*145CM	1	
3	Adhesive Side Drape 75*90CM	2	
4	Adhesive Bottom Drape 150*180CM	1	
5	Adhesive Top Drape 150*240CM	1	
6	Hand Towel 30*40CM	4	
7	OP Tape Strip 10*50CM	1	
8	Reinforced Surgical Gown, L size	2	

Laparoscopy Pack

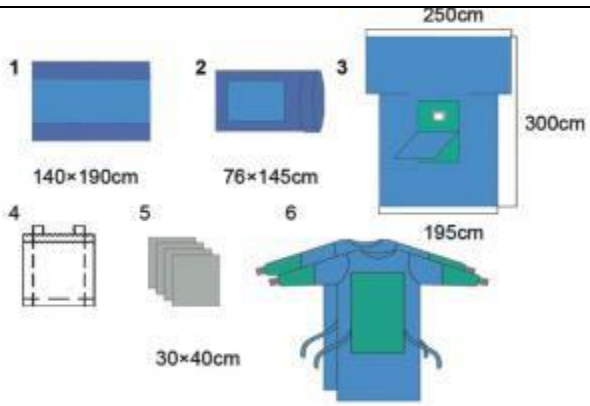
No	Description	QTY	Picture
1	Back Tale Cover 140*190CM	1	
2	Mayo Stand Cover 78*145CM	1	
3	Laparoscopy Drape, 195*250*300cm, reinforcement 100*75cm, with 25*30cm fenestration, 5cm adhesive around, perineal fenestration 20*10cm, with 2.5cm tape, with flap over both fenestration	1	
4	Suture Bag	1	
5	Hand Towel 30*40CM	4	
6	Reinforced Surgical Gown, L size	2	

Laparotomy Pack

No	Description	QTY	Picture
1	Back Tale Cover 140*190CM	1	
2	Mayo Stand Cover 78*145CM	1	
3	Laparoscopy Drape, 195*250*300cm, reinforcement 100*75cm, with 25*30cm fenestration, 5cm adhesive around, perineal fenestration 20*10cm, with 2.5cm tape, with flap over both fenestration	1	
4	Utility Drape with adhesive 38*66cm	4	
5	1/2 Drape with Adhesive 38*66	2	
6	Suture Bag	1	
7	Hand Towel 30*40CM	4	
8	Reinforced Surgical Gown, L size	2	

Split Drape Pack

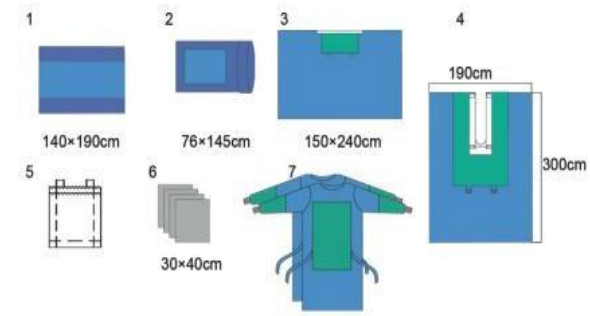
No	Description	QTY	Picture
1	Back Tale Cover 140*190CM	1	
2	Mayo Stand Cover 78*145CM	1	
3	Adhesive Top Drape 150*240CM, Reinforcement 40*60cm	1	
4	U Split Drape, 190*300cm, Split 20*80cm, with 5cm adhesive and absorbent 60*120cm tube holder	1	
5	Suture Bag	1	
6	Hand Towel 30*40CM	4	
7	Reinforced Surgical Gown, L size	2	

Orthopedic Procedure Pack

Extremity Pack with Gown

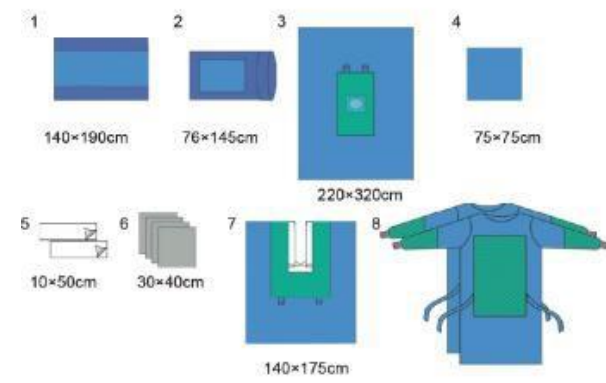
No	Description	QTY	Picture
1	Back Tale Cover 140*190CM	1	
2	Mayo Stand Cover 78*145CM	1	
3	Extremity Drape, 220*320CM	1	
4	Utility Drape, 75*75cm	1	
5	OP Tape Strip 10*50CM	1	
6	Impervious Split Drape, 140*175cm, 10*50cm, U cut Adhesive Split	1	
7	Hand Towel 30*40CM	4	
8	Reinforced Surgical Gown with 2pcs hand towel, XL size	1	

Shoulder Beach Chair Drape

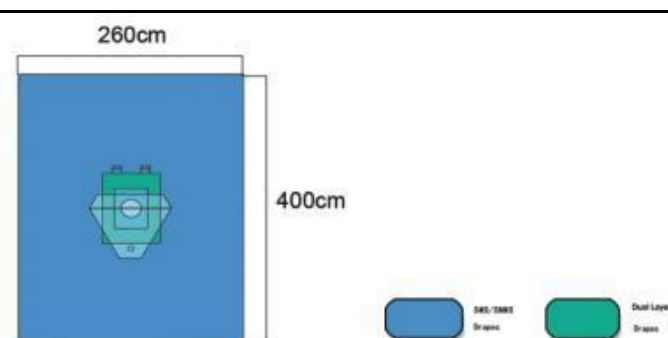
Size	Description	Picture
260*400CM	Reinforcement 75*50cm, Elastic fenestration 6cm, Fluid collection pouch 75*9cm with 1 valve, 2 Velcro Tube holders	

Shoulder Arthroscopy Drape

Size	Description	Picture
250*160CM	Split 15*50cm, Fluid collection pouch 27*115cm with 2 valve, Tape 5cm	

Hand Pack with Gown

No	Description	QTY	Picture
1	Back Tale Cover 140*190CM	1	
2	Mayo Stand Cover 78*145CM	1	
3	Hand Drape 27*300*160cm, Elastic Fenestration 18*18cm with opening Dia.3cm, Absorbent reinforcement 50*80cm	1	
4	Medium Drape with Adhesive, 100*150cm	1	
5	OP Tape Strip 10*50CM	2	
6	Hand Towel 30*40CM	4	
7	Reinforced Surgical Gown with 2pcs hand towel, XL size	2	

Hand &Foot Pack with Gown

No	Description	QTY	Picture
1	Back Tale Cover 140*190CM	1	
2	Mayo Stand Cover 78*145CM	1	
3	Hand&Foot Drape 180*300cm, Elastic fenestration 18*18cm with opening Dia.3cm, Absorbent reinforcement 50*140cm	1	
4	Medium Drape with Adhesive, 100*150cm	1	
5	OP Tape Strip 10*50CM	2	
6	Hand Towel 30*40CM	4	
7	Reinforced Surgical Gown with 2pcs hand towel, XL size	2	

Knee Arthroscopy Pack with Gown

No	Description	QTY	Picture
1	Back Tale Cover 140*190CM	1	
2	Mayo Stand Cover 78*145CM	1	
3	Arthroscopy T Drape 220*280*290cm, fluid collection pouch 83*78cm, Circular Elastic fenestration 6cm, Absorbent reinforcement 75*120cm	1	
4	Suture Bag	1	
5	OP Tape Strip 10*50CM	2	
6	Hand Towel 30*40CM	4	
7	Reinforced Surgical Gown with 2pcs hand towel, XL size	2	

Hip Pack with Gown

No	Description	QTY	Picture
1	Back Tale Cover 140*190CM	1	
2	Mayo Stand Cover 78*145CM	1	
3	Hip Drape 250*290*320CM	1	
4	Suture Bag	1	
5	OP Tape Strip 10*50CM	2	
6	Hand Towel 30*40CM	4	
7	Impervious Stockinette, Medium 23*100cm	1	
8	Reinforced Surgical Gown with 2pcs. hand towel, XL size	2	

Orthopedic pack with Gown

No	Description	QTY	Picture
1	Back Tale Cover 140*190CM	1	
2	Mayo Stand Cover 78*145CM	1	
3	Ortho U Split Drape 200*300cm	1	
4	Suture Bag	1	
5	OP Tape Strip 10*50CM	2	
6	Hand Towel 30*40CM	4	
7	Impervious Stockinette, Medium 23*100	1	
8	Reinforced Surgical Gown with 2pcs hand towel, XL size	2	

Disposable Sterile C-Section Surgical Pack			
No	Description	QTY	Picture
1	Back Tale Cover 140*190CM	1	
2	Mayo Stand Cover 78*145CM	1	
3	C-section Drape, fluid collection pouch with 2 suction port 72*80cm and forming wire, full incision film 40*40cm, tube holders, Arm board covers, 240*300*195cm	1	
4	Hand Towel 30*40CM	4	
5	Reinforced Surgical Gown with 2pcs. hand towel, XL size	3	
6	Baby Blanket 60*90cm	2	

Disposable Sterile Caesarean Pack

No	Description	QTY	Picture
1	Back Tale Cover 140*190CM	1	
2	Mayo Stand Cover 78*145CM	1	
3	C-section Drape 240*300*195cm, fluid collection pouch with 2 suction port 72*75cm and forming wire, full incision film. 34*34cm with Teardrop fenestration 24*20cm, 4tube holders, arm board covers	1	
4	Hand Towel 30*40CM	6	
5	Reinforced Surgical Gown with 2pcs. hand towel, XL size	3	
6	Baby Blanket 60*90cm	1	
7	Gauze Swab, 16Ply, with X ray	20	
8	Abdominal Mops-X rayed, 4ply, with string, 45*45cm	10	
9	Cord Clamp	1	
10	Placenta Basin, with white lead, 31.5*24.5*7cm	1	
11	Suture Bag	1	
12	Suction Tube and Nozzle	1	
13	Omphacut	1	
14	Under Pad 90*120cm	1	
15	SMS Wrap, 100*100cm	1	

Obstetrics Pack

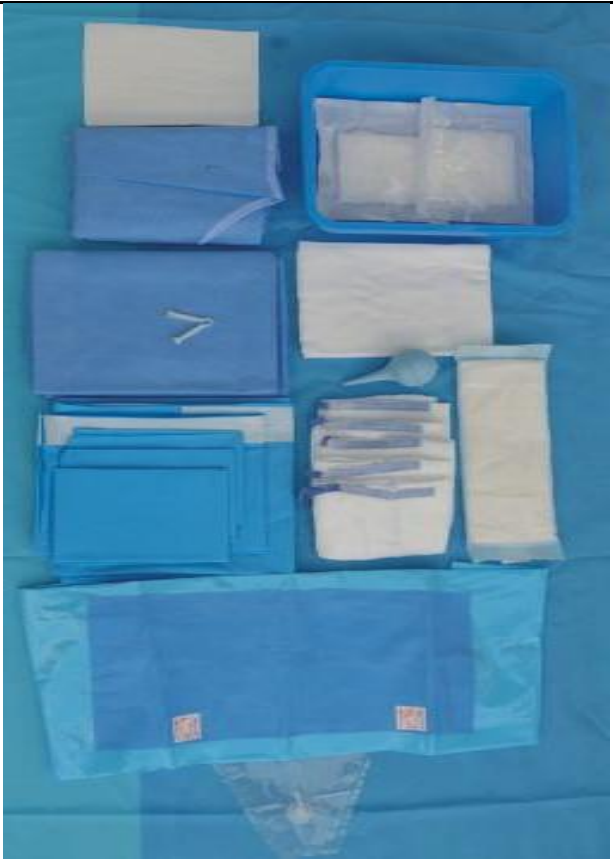
No	Description	QTY	Picture
1	Back Tale Cover 112*190	1	
2	Under Buttocks Drape, with fluid collection pouch, absorbent zone 76*110cm	1	
3	Hand towel 30*40cm	1	
4	Abdominal Drape Reinforced 100*150cm	1	
5	Legging, 15cm Cuff 75*120cm	2	
6	Standard Surgical Gown, AR6-8, L	1	
7	Baby Blanket 60*90cm	1	
8	Maternity Pads 10*32cm	2	
9	Cord Clamp	1	
10	Bulb Syringe	5	
11	Gauze,8Ply, with Xray, 10*10cm	5	
12	Small Tray	1	
13	Placenta Basin 24.5*13.5*5cm	2	
14	Vaginal Cotton Stick	1	

Lithotomy Pack

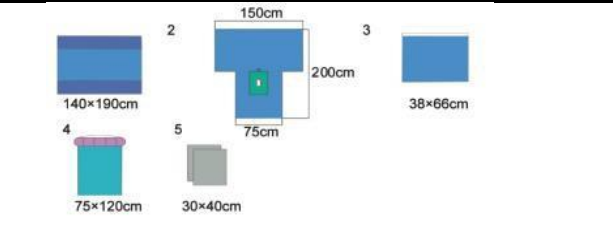
No	Description	QTY	Picture
1	Back Tale Cover 140*190CM	1	
2	Lithotomy T Drape 150*220*75cm	1	
3	Utility Drape with adhesive 38*66cm	1	
4	Hand Towel 30*40CM	2	
5	Legging 75*120cm	2	

Ophthalmology Surgery Drape Pack			
No	Description	QTY	Picture
1	Equipment Table Cover 75*100cm	1	
2	Ramsey Dressing Forceps 14cm	1	
3	Cotton Buds	10	
4	Surgical Gown, 45gsm SMS, L	2	
5	Gauze Sponge 10*10cm	10	
6	Eye Shield, Clear, Universal	1	
7	Syringe without needle Luer Slip 10ml	1	
8	Syringe without needle Luer Slip 3ml	2	
9	Syringe without needle Luer Slip 5ml	1	
10	Syringe without needle Luer Slip 1ml	3	
11	Eye 6*8cm	2	
12	Eye Drape 140*120cm, SMS 45gsm	1	
13	Hand Towel 30*40cm	4	
14	Medical Cup 3OZ	2	
15	Kidney Dish 700ml	1	
16	Hypodermic Needle 25G	1	
17	Hypodermic Needle 23G	3	
18	Hypodermic Needle 18G	1	
19	Hypodermic Needle 27G	1	

Ear, Nose & Throat Pack

No	Description	QTY		
1	Back Tale Cover 140*120cm	1		
2	Mayo Stand Cover 58*137cm	1		
3	Head Turban Drape 75*120cm	2		
4	ENT Split drape 190*300cm	1		

Neuro Pack

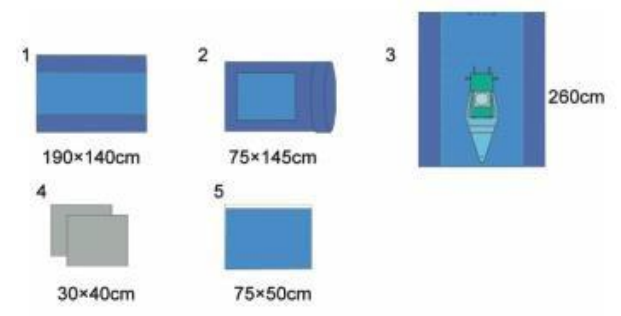
No	Description	QTY	Picture
1	Back Tale Cover 140*190cm	1	
2	Mayo Stand Cover 76*145CM	1	
3	Craniotomy drape 250*260cm, with incise film and pouch, oval fenestration	1	
4	Absorbent Towel 30*40cm	2	
5	Utility Drape with adhesive tape 75*50cm	2	

Craniotomy Drape

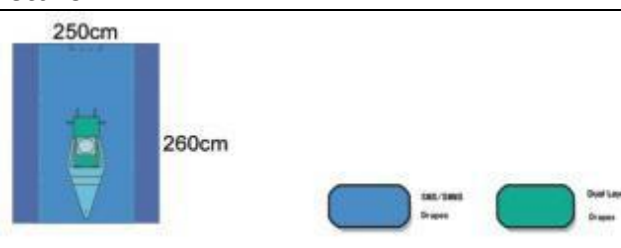
	Description	Size(cm)	Picture
	50cm PE panel on both sides, Absorbent reinforced 5*16cm, Fluid Collection Pouch 50*76cm, Forming Wire, Mesh Strainer, Drainage Port, Oval Incise Film 26*20cm, Velcro Holding tube.	250*260 cm	

Craniotomy T Drape

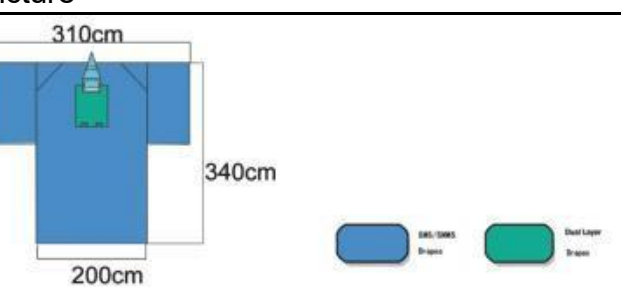
	Description	Size(cm)	Picture
	Absorbent Reinforced 90*60cm, Fluid Collection Pouch 60*90cm, Forming Wire, Mesh Strainer. Drainage Port, Oval incise film 26*20cm, Velcro Holding Tabs, Gusseted Anesthesia Panels	310*200*340CM	

Angiography Drape Pack

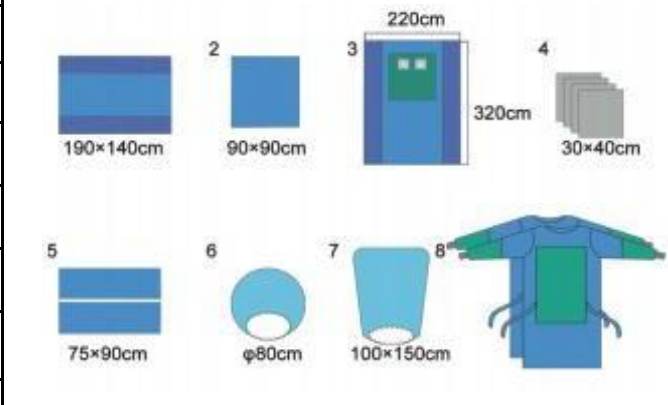
No	Name	QTY	Picture
1	Back Table Cover 190*140cm	1	
2	Sterilization wrap 90*90cm	1	
3	Femoral Angiography drape 220*320cm	1	
4	Hand Towel 30*40CM	4	
5	Medium Drape 75*90cm	1	
6	Light Cover Round, Dia 80cm	1	
7	Light Cover Square, 100*150cm	1	
8	Reinforced surgical gown, XL	2	

Angiography Drape

Size	Description	Picture
220*320cm	Dual Clear Panels 50cm width, Absorbent Reinforcement 75*100cm, two fenestration dia 14cm, two incise film with fenestration dia 7.5cm	

Radial Femoral Angiography Drape

Size	Description	Picture
220*320cm	Dual Clear Panels 50cm width, Absorbent Reinforcement 75*100cm, Femoral fenestration Dia 12cm, Incise film with fenestration Dia 8cm, Radial fenestration oval 12cm*8cm, with fenestration Dia 6*4cm	

Femoral Angiography Drape with Pouch

Size	Description	Picture
240*370cm	Dual Clear side Panels 50cm width, Absorbent Reinforcement 125*130cm, 2 collection pouch 125*15cm, Femoral fenestration Dia 12cm, incise film with fenestration Dia 6cm, Radial fenestration Dia 6cm, Radial fenestration 12cm, with fenestration Dia 9cm	

Brachial Angiography Drape

Size	Description	Picture
80*110cm	Absorbent Reinforcement 30*60cm, round central fenestration of 7cm with incise film	

Cardiovascular Pack

No	Description	QTY	Picture
1	Back Table Cover 190*140cm	1	
2	Sterilization wrap 100*100cm	1	
3	Cardiovascular drape 200*300*350cm	1	
4	Hand Towel 30*40CM	4	
5	Perinca Drape 190*240cm	1	
6	Foot Cover	2	
7	Utility Drape with adhesive 75*75cm	2	
8	Op Tape 10*50cm	1	
9	Suture Bag	1	
10	Standard Surgical Gown, XL	2	
11	Mayo Stand Cover 76*145cm	1	